

### **ANTES DE COMENZAR**

Asegúrese de disponer de espacio libre de obstáculos con unas dimensiones aproximadas de 5,2x4,5 metros, con lo que dispondrá de un pasillo perimetral de 1 metro alrededor del portapalets.

Siga las indicaciones de este manual para su correcto montaje.

### **INDICACIONES DE SEGURIDAD**

Es obligatorio el uso de guantes y calzado de seguridad.

Preste especial atención, a posibles arañosos y atrapamientos durante el montaje.

### **HERRAMIENTAS**

Las herramientas necesarias para el correcto montaje son:

- Pistola neumática o llaves de carraca (vaso 13 y 17)
- Llaves fijas para el montaje nº 13 y 17
- Remachadora neumática para remaches 6,4 AC/AC

### **POSICIÓN SOBRE REMOLQUE**

La posición correcta es la indicada en la imagen siguiente:

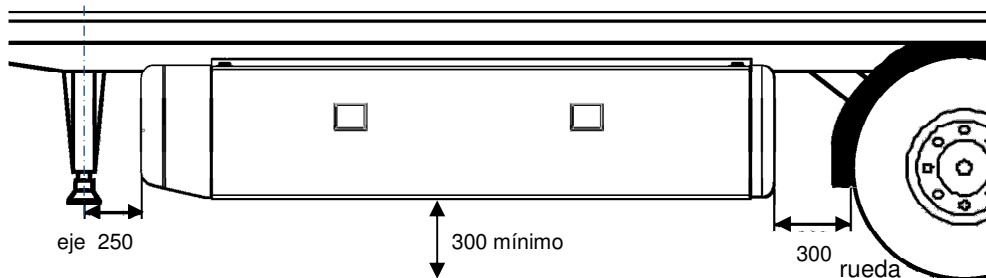

**Imas DBB 2010 s.a.**

Teléfono de contacto 964 371 023

[imasdbb@gmail.com](mailto:imasdbb@gmail.com)

Polígono industrial "La Mezquita", parcela 610, 12.600 La Vall d'Uixó (Castellón)

# MANUAL DE MONTAJE

PORTAPALETES CERRADO 36, 30 Y 24 PALETS

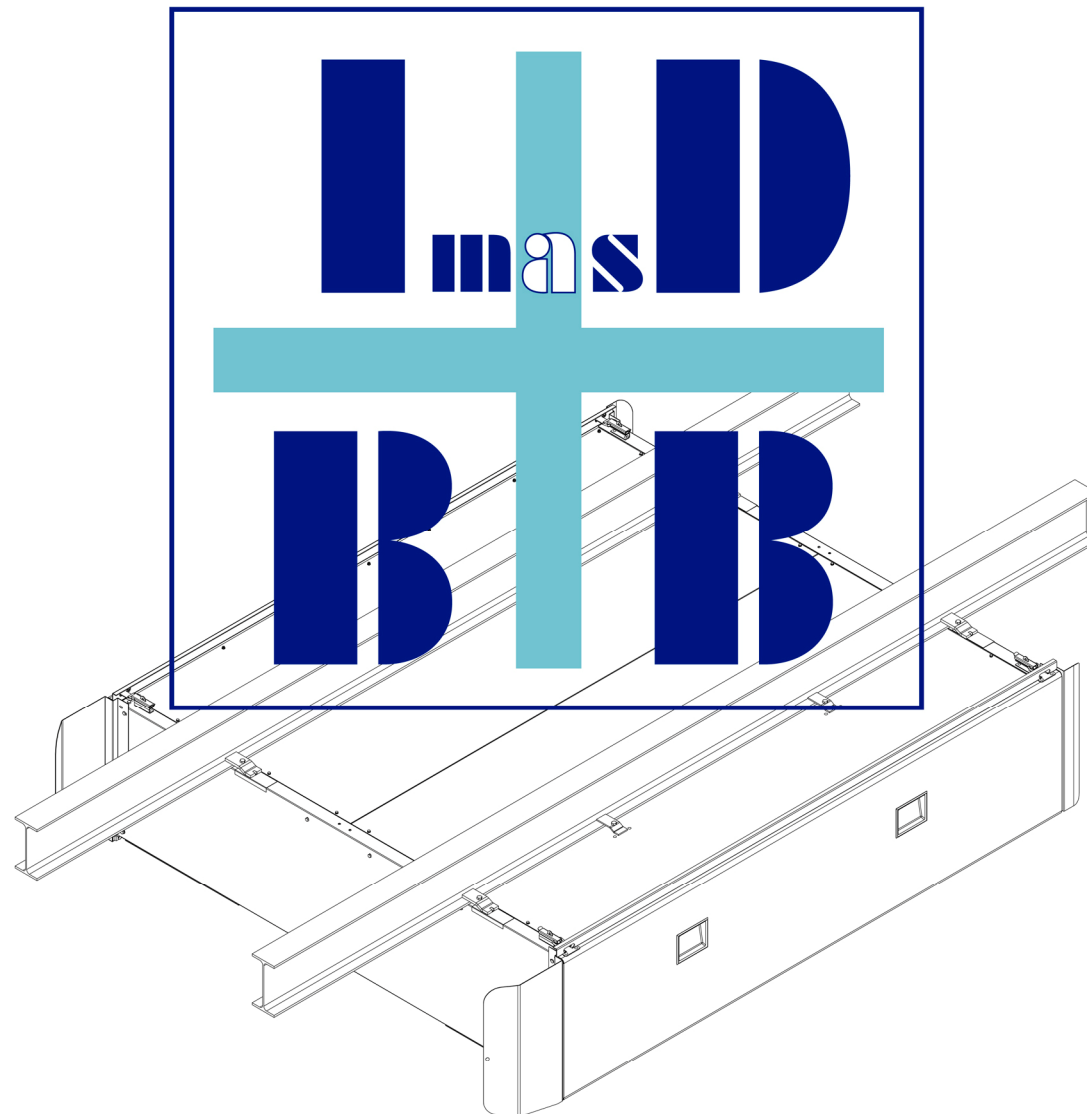



**Inmas DDBB 2010 s.a.**

**IMPORTANTE ASEGURARSE NO DEJAR SEPARACIÓN ENTRE EL LATERAL Y EL SUELO EN EL MOMENTO DE APRETAR LOS TORNILLOS (PASO B)**

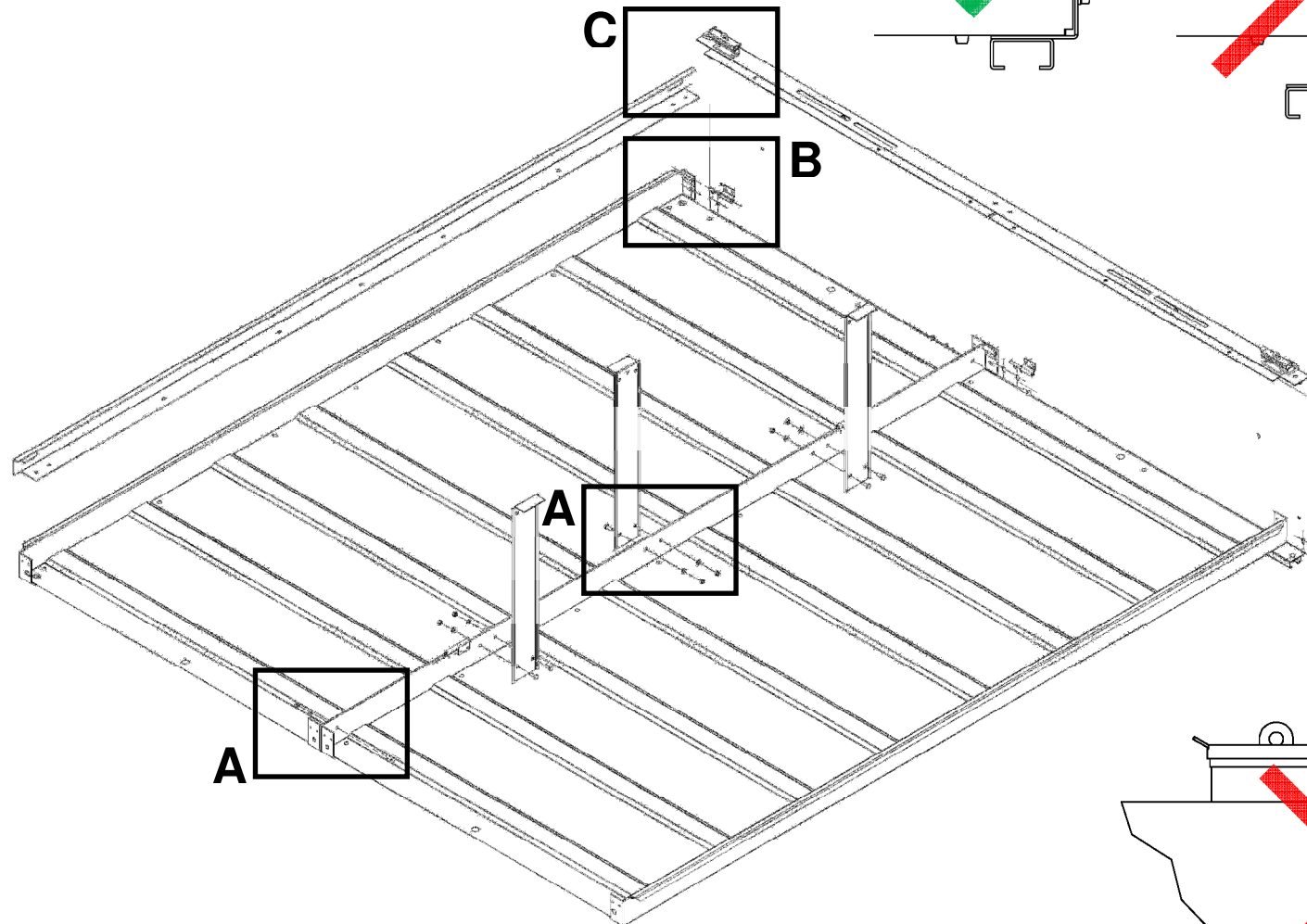
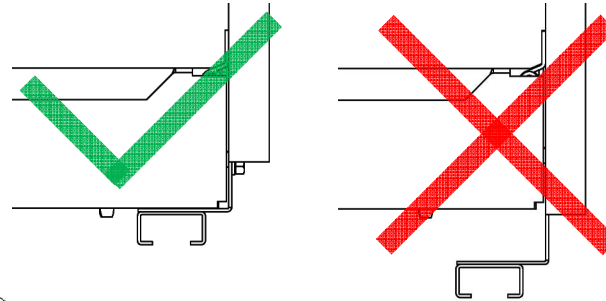

**PASO 1: ELEVAR 60 mm. MÍNIMO DEL SUELO PARA MONTAJE DESPLEGADO**

**PASO 2: FIJAR SUELOS PANELES CENTRALES**

OBSERVAR ORIENTACIÓN  
(BOLSA 1), 8 uds

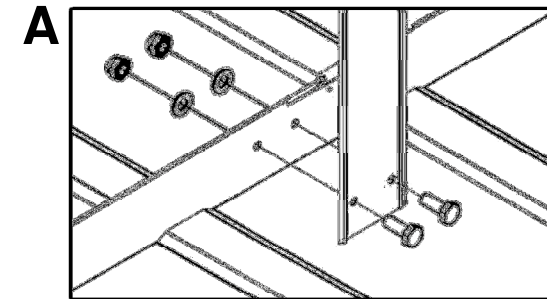

**PASO 3: FIJACIÓN DE LATERALES**

ALINEAR PASADORES Y ENCAJAR  
(BOLSA 2), 4 uds x lateral

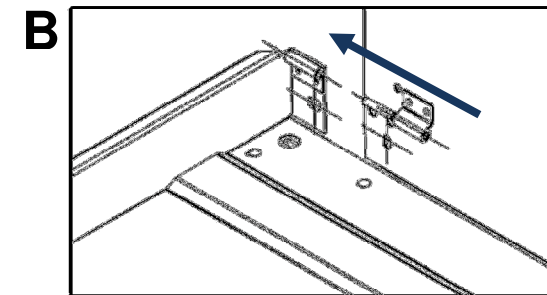

**PASO 4: FIJACIÓN MOLDURAS**

FIJAR POR PARTE INFERIOR LATERAL  
(BOLSA 1), 2 uds x moldura

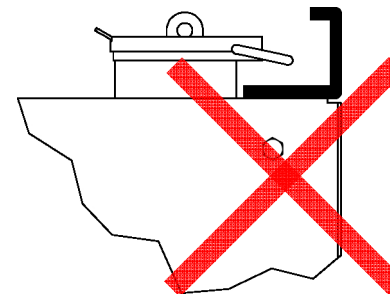
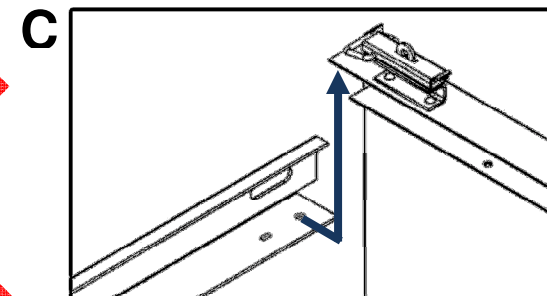

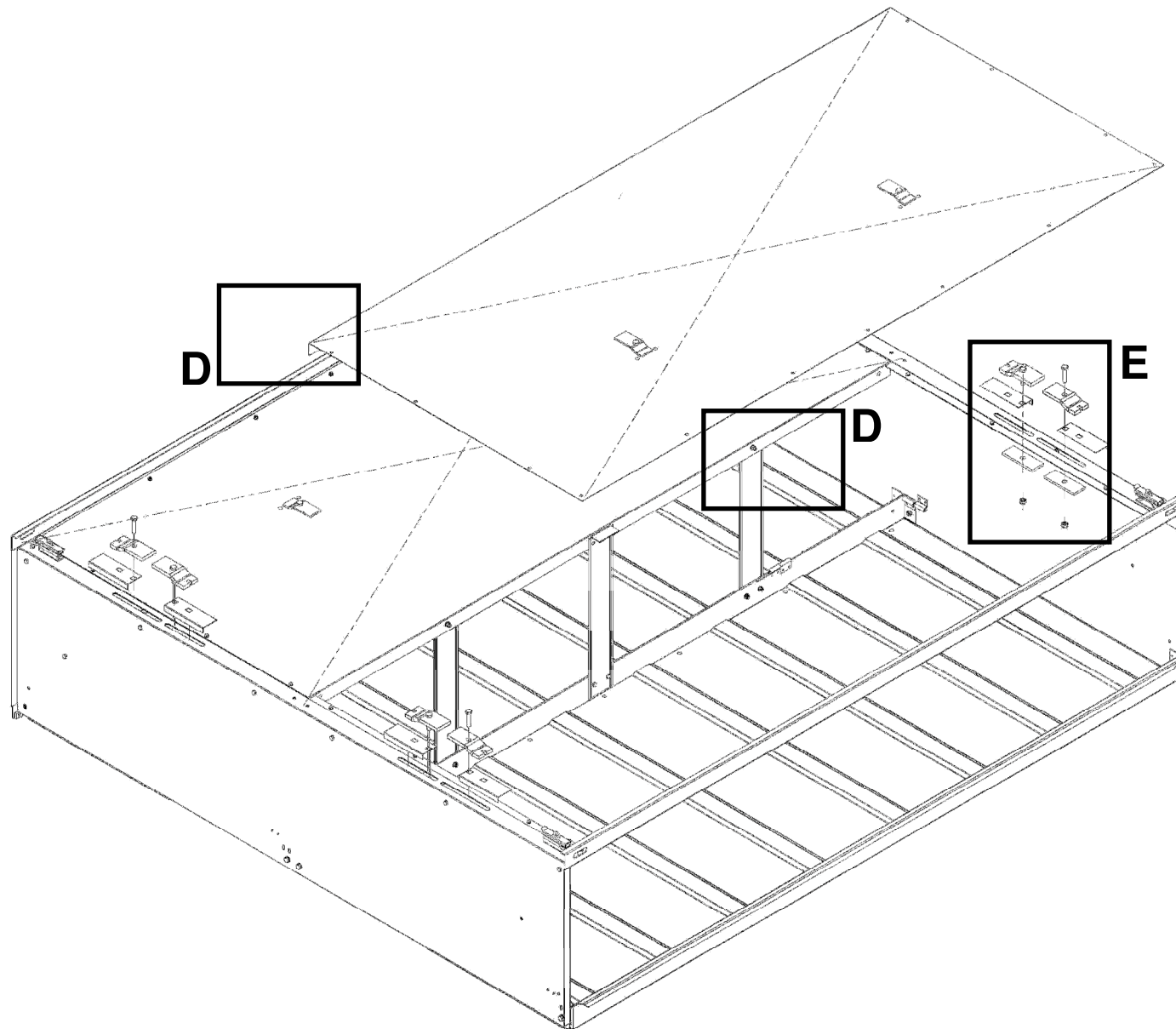

**PASO 5: UNIÓN TECHOS Y  
PANELES CENTRALES**  
(BOLSA 1). 5 uds con DOBLE ARANDELA

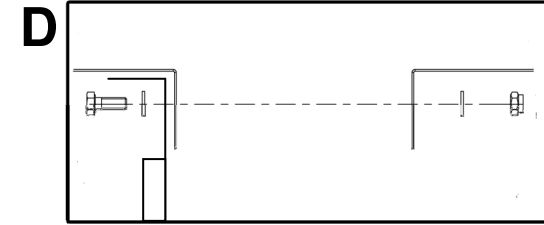

**PASO 6: MONTAR UÑAS ANCLAJE**  
(BOLSAS 4 Y 6)

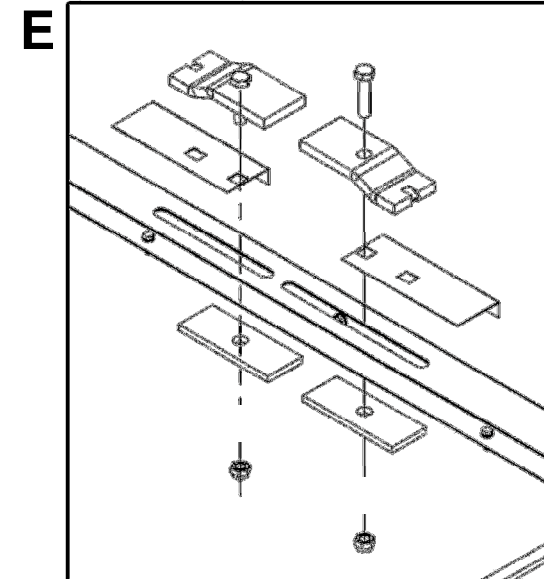

**PASO 6.1: MONTAJE EN CHASIS**  
ABRIR LAS UÑAS Y GIRAR

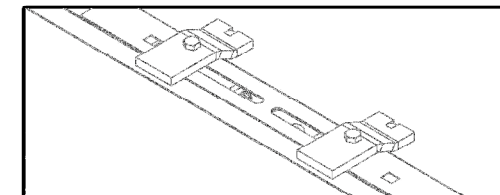

**PASO 6.2: ANCLAR AL CHASIS**  
GIRAR LAS UÑAS SOBRE LA VIGA

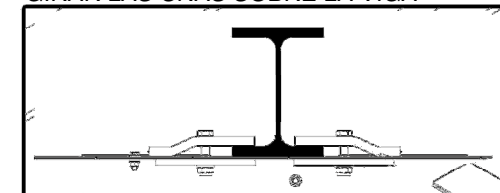



**Inmas DBB 2010 s.a.**

**PASO 7: FIJAR SALVACICLISTAS Y EMBELLECEDORES TRASEROS**

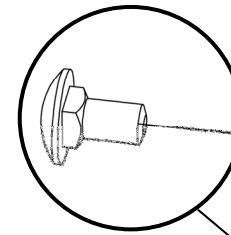

**F**

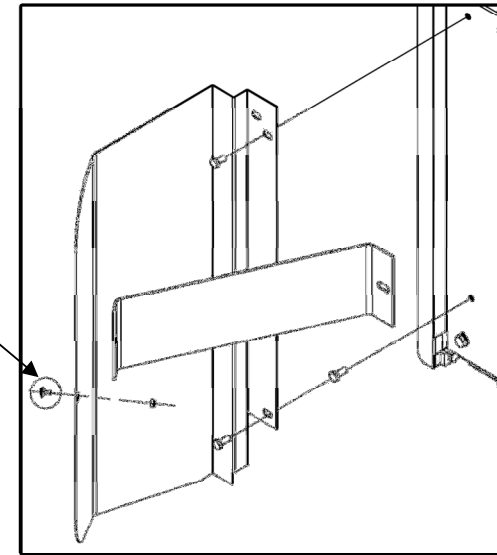

**PARTE TRASERA**

(BOLSA 3)

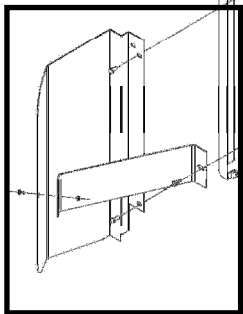

**F**

**PARTE DELANTERA**





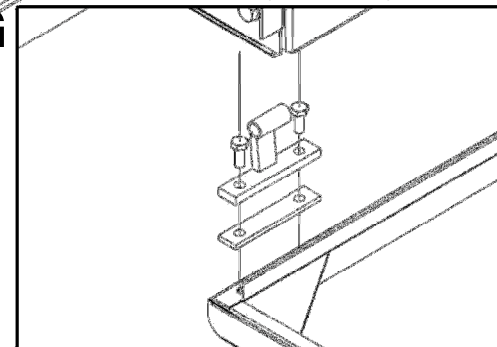













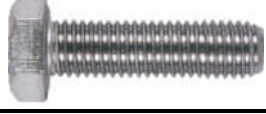





**PASO 8: COLOCACIÓN BISAGRAS (BOLSA 5T)**

**G**

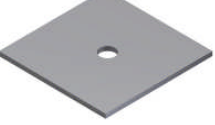

**G**

**CONTENIDO PARA MONTAJE PORTAPALETES CERRADO**

<p><b>BOLSA 1</b></p>	<p>TORNILLO M8 x 20 (24 unidades)</p> 	<p>ARANDELA M-8 (32 unidades)</p> 	<p>TUERCA M-8 (24 unidades)</p> 
<p><b>BOLSA 2</b></p>	<p>TORNILLO M10 x 20 (8 unidades)</p> 	<p>ARANDELA M-10 (8 unidades)</p> 	<p>TUERCA M-10 (8 unidades)</p> 
<p><b>BOLSA 3</b></p>	<p>TORNILLO M8x20 DIN603 (2 unidades)</p> 	<p>ARANDELA M-8 DIN 125A (2 unidades)</p> 	<p>TUERCA M-8 (2 unidades)</p> 
	<p>TORNILLO M8 x 20 (10 unidades)</p> 	<p>ARANDELA M-8 (10 unidades)</p> 	<p>TUERCA M-8 (10 unidades)</p> 
<p><b>BOLSA 4</b></p>	<p>TORNILLO M14 x 60 (4 unidades)</p> 		<p>TUERCA M-14 (8 unidades)</p> 
<p><b>BOLSA 5T</b></p>	<p>TORNILLO M8 x 25 (8 unidades)</p> 	<p>BISAGRA (4 unidades)</p> 	<p>TUERCA M-8 (8 unidades)</p> 
		<p>PLETINA (4 unidades)</p> 	
<p><b>BOLSA 6T</b></p>	<p>REMACHES 6,4x12 (26 unidades)</p> 	<p>TAPONES (6 unidades)</p> 	<p>TUERCA M-10 (4 unidades)</p> 
	<p>TORNILLO M10x 35 (4 unidades)</p> 	<p>UÑAS 50x5 (4 unidades)</p> 	<p>REFUERZO UÑA TECHO (4 unidades)</p> 
	<p>CHAPA CUBRECOLIS (4+4 unidades)</p> 	<p>ARANDELA M-10 (4 unidades)</p> 	

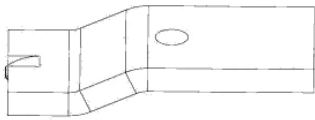

**UÑA (4 unidades)**

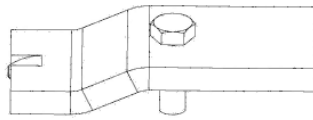

**UÑA INTERIOR (4 unidades)**



**REFUERZO UÑA (8 unidades)**

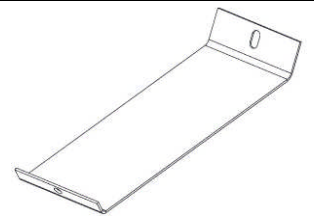

**REFUERZO SALVACICLISTAS (2 unidades)**

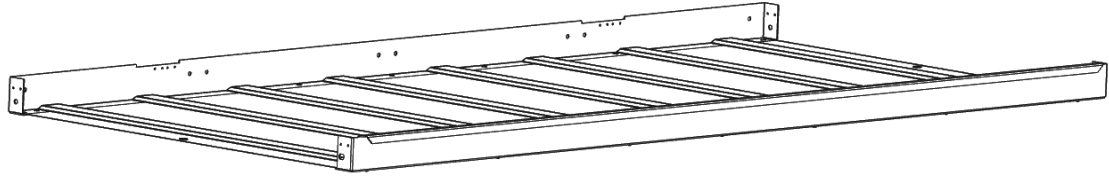

**SUELO (2 unidades)**

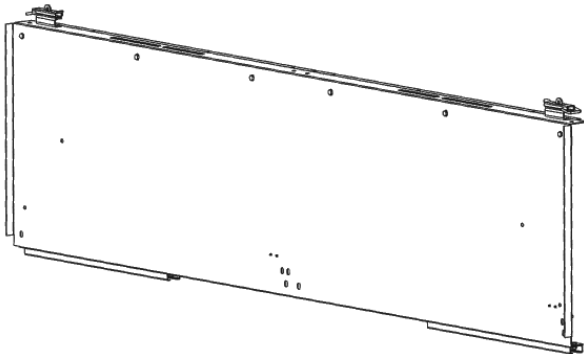

**LATERAL (2 unidades)**

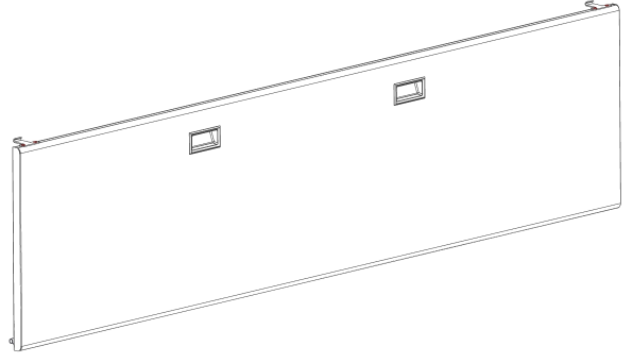

**PUERTAS (2 unidades)**

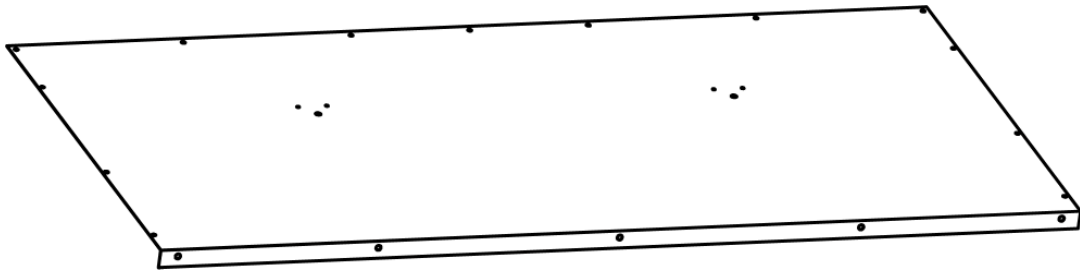

**TECHOS (2 unidades)**



**OMEGA (3 unidades)**

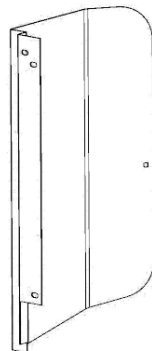

**SALVACICLISTAS (2 unidades)**



**EMBELLECEDOR (2 unidades)**

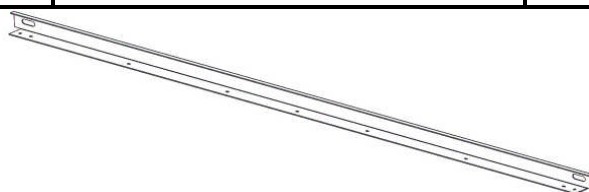

**MOLDURA TOPE PUERTA (2 unidades)**